

ECP9641X
ECP6641X

EN Cooker hood

User Manual

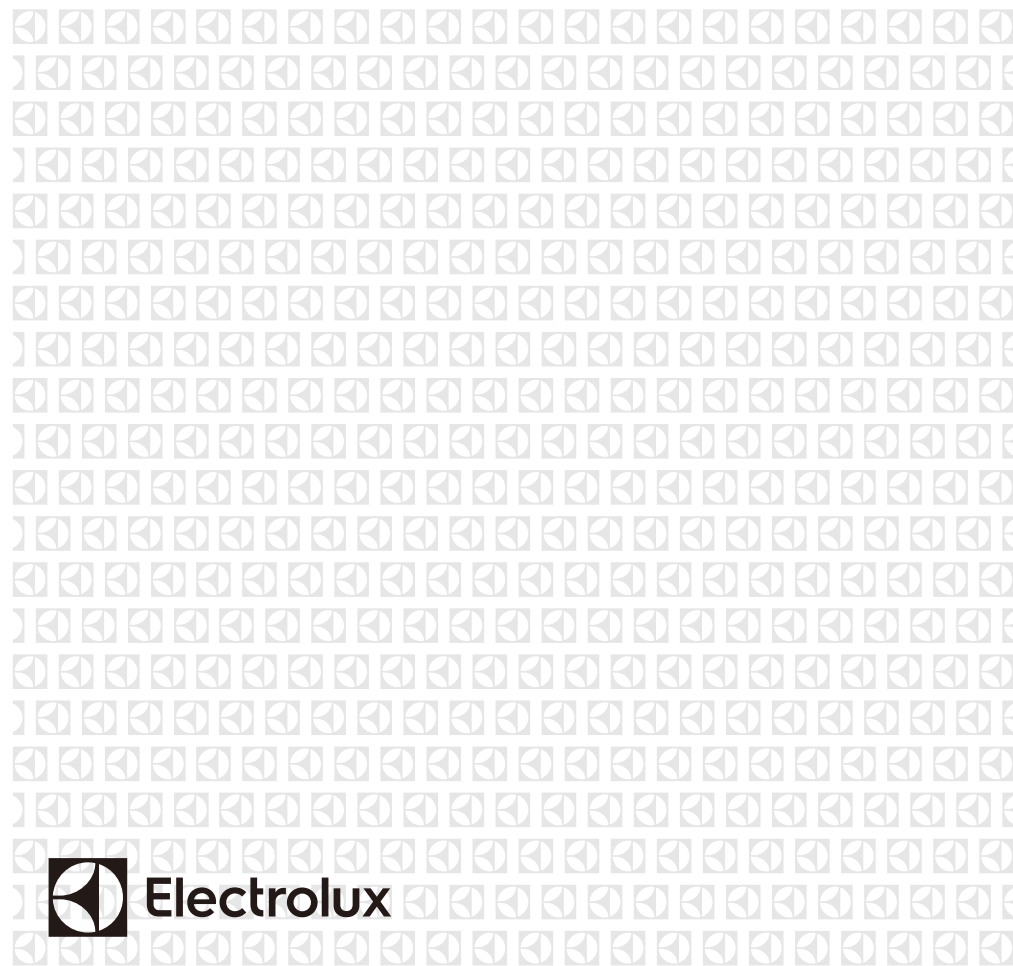

WE'RE THINKING OF YOU

Thank you for purchasing an Electrolux appliance. You've chosen a product that brings with it decades of professional experience and innovation. Ingenious and stylish, it has been designed with you in mind. So whenever you use it, you can be safe in the knowledge that you'll get great results every time. Welcome to Electrolux.

BEFORE USING YOUR APPLIANCE

Before you use the rangehood, we recommend that you read through the whole user manual which provides the description of the rangehood and its functions. To avoid the risks that are always present when you use an electrical appliance, it is important that the rangehood is installed correctly and that you read the safety instructions carefully to avoid misuse and hazards.

For future reference, please store this booklet in a safe place.

CONDITIONS OF USE

This appliance is intended to be used in household and similar applications such as

- Staff kitchen areas in shops, offices and other working environments
- Farm houses
- By clients in hotels, motels and other residential type environments
- Bed and breakfast type environments

BEFORE YOU CALL

Please ensure you read the instruction manual fully before you call for service, or a full service fee could be applicable.

RECORD MODEL AND SERIAL NUMBER HERE:

Model: _____

Serial NO: _____

CONTENTS

- 3 Safety information
- 4 Product description
- 5 Dimensions
- 6 Rangehood installation
- 8 Operation
- 8 Maintenance and cleaning
- 9 Troubleshooting
- 10 Consumer Care Center

LEGEND

WARNING!

This symbol indicates information concerning your personal safety

CAUTIONS!

This symbol indicates information on how to avoid damaging the rangehood.

IMPORTANT!

This symbol indicates tips and information about use of the rangehood.

ENVIRONMENT!

This symbol indicates tips and information about economical and ecological use of the rangehood.

RoHS Compliant.

If at any time in future you need to dispose of this product please do Not dispose of this product with household waste, please send this product to collecting points where available

This product is RoHS compliant.

SAFETY INFORMATION

This manual explains the proper use of your new Electrolux canopy rangehood. Please read this manual carefully before using the product. This manual should be kept in a safe place for handy reference.

This rangehood is a domestic appliance which has been manufactured and tested to comply with International Standard IEC 60335.2.31.













Read the following carefully to avoid damage or injury.

 **This symbol indicates never to do this**

 **This symbol indicates always do this**

WARNING!

Follow these instructions carefully to avoid an electric shock or fire.

-  Young children should be supervised to ensure they do not play with the rangehood.
-  This appliance is not intended for use by persons (including children) with reduced physical, sensory or mental capabilities, or lack of experience and knowledge, unless they have been given supervision or instruction concerning the use of the appliance by a person responsible for their safety.
-  Ensure the rangehood is switched off before carrying out maintenance, to avoid any possibility of electric shock.
-  Never carry out flambe cooking under the rangehood.
-  This rangehood is not recommended for barbecues.
-  This rangehood cannot be installed for external use.
-  Grease filters must be removed every four weeks (maximum) for cleaning to reduce the risk of fire.
-  The exhaust from the rangehood must not be discharged into any heating flue, which may carry combustion products from other sources.(Fig.1)
-  The exhaust air must not be discharged into a wall cavity, unless the cavity if designed for the purpose.
-  There must be adequate ventilation of the room when the rangehood is used at the same time as appliances burning gas or other fuels.
-  Always cover lit gas burners with pots or pans when rangehood is in use.
-  Always switch off gas burners before you remove pots or pans.
-  Do not leave lit gas burners exposed due to the risk of fire.(Fig.2)

Electrical connection

Check that the mains voltage matches with the voltage on the data plate inside the rangehood. Check that the installation complies with standards of local building, gas and electrical authorities. Before connecting to the mains supply ensure that the mains voltage corresponds to the voltage on the rating plate inside the rangehood. If the supply cord is damaged, it must be replaced by the manufacturer or its service agent or similarly qualified person in order to avoid a hazard.

Safety warnings For the installer

When installing the rangehood, make sure you adhere to the minimum and maximum distances from the rangehood base to the hob surface (as per table on page 6).

Exhaust flue installation: The following rules must be strictly followed to obtain optimal air extraction.

- Keep exhaust flue short and straight
- Do not reduce the size or restrict exhaust flue.
- Keep bends in the exhaust flue to a minimum.
- When using flexible flue always install duct with helix pulled taut to minimise pressure loss.
- Failure to observe these basic instructions will drastically reduce the performance and increase the noise levels of the range hood.

Exhaust air must not be discharged into a wall cavity, unless the cavity is designed for the purpose. The exhaust from the cooker hood must not be discharged into any heating flue, which may carry combustion products from other sources.

NOTE: Some installations may require the telescopic exhaust cover to be cut to length. Cut with sharp tin snips or a fine-tooth hack saw blade, taking care not to distort or dent the exhaust cover.

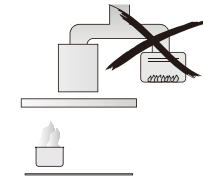

Fig. 1

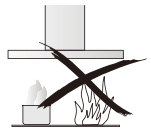

Fig. 2

PRODUCT DESCRIPTION

ECP9641X
ECP6641X

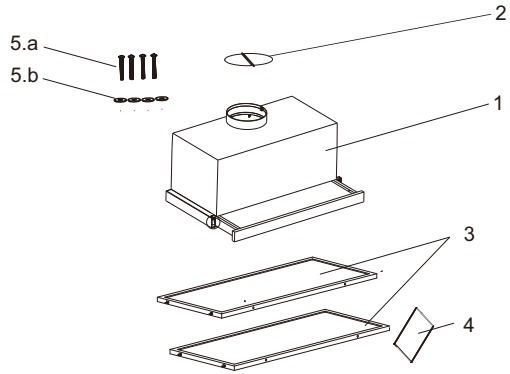

Fig.3

COMPONENTS

Ref	Qty	Product Components
1	1pc	Hood body, complete with: controls, lights, blower
2	2pcs	Damper (flaps)
3	2pcs	Aluminium mesh filter
4	1pc	Instruction manual
5.a	4pcs	Mounting Screws
5.b	4pcs	Mounting gasket

DIMENSIONS

ECP9641X

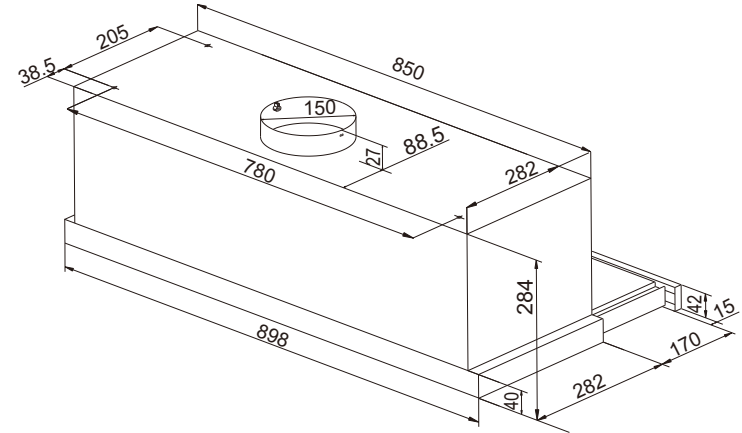

Fig.3

ECP6641X

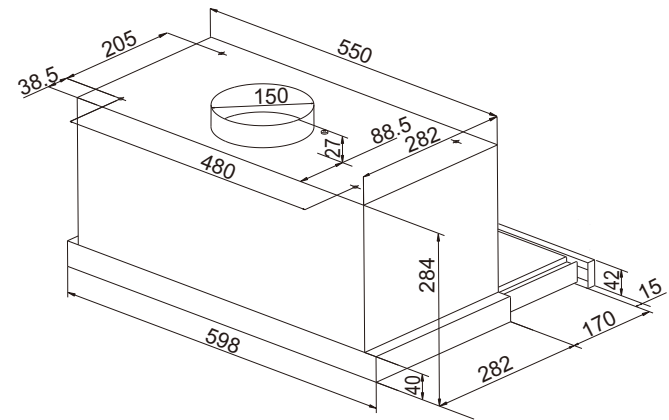

Fig.4

RANGE HOOD INSTALLATION

⚠ WARNING!

Refer to "Safety information" chapter

ℹ BEFORE INSTALLATION

Before the installation of the appliance, record the information below from the rating plate. The rating plate is on the bottom of the appliance casing.

Model _____
 PNC _____
 Serial number _____

- The hood is to be mounted on the mounting board of the cabinet. When installed, the hood must be not less than 65cm above electric burners or 75cm above gas or mixed-fuel burners. (Fig.5)

* If the instructions of the hob specify a greater distance than the minimum above, then that shall be the minimum height for installation.

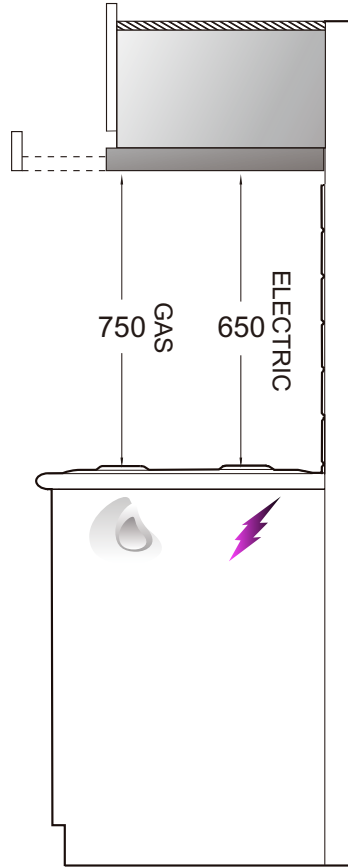

Fig.5

RANGE HOOD INSTALLATION

Before installation, please make cabinet according to below diagram

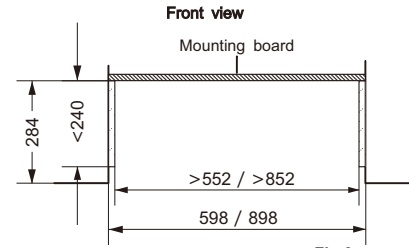

Fig.6

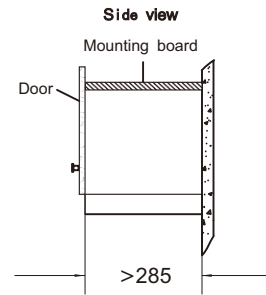

Fig.7

After installation

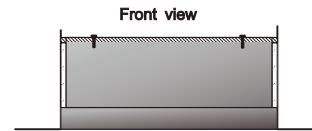

Fig.8

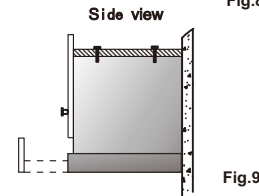

Fig.9

- Drill a hole of 165mm diameter, 4X $\phi 8$ mounting holes and one clearance hole of 70mm diameter for power cord on the cabinet board, respecting the distance indicate in Fig.10.

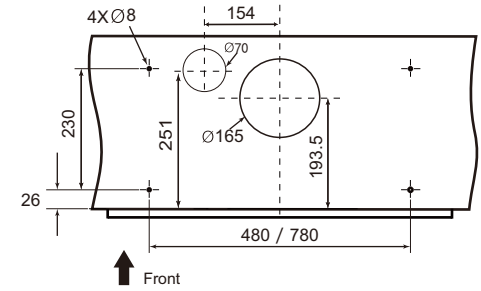
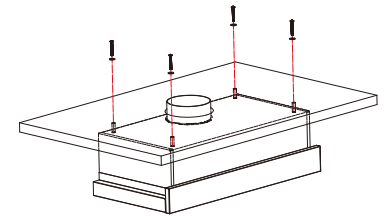

Fig.10

- Insert 4 mounting screws with 4 mounting gaskets to fix the hood. (Fig.11)



- Fit the flexible flue(not supplied) to the duct transition Use fixing tape to secure flexible pipe to the duct transition.(Fig.12)

NOTE: For ducted mode, we recommend extending flue pipe through the roof to external" roof cap"to vent exhaust externally. We do not recommend venting into ceiling cavity.

NOTE: To ensure optimum performance of the range hood, the use of rigid ducting is recommended. the use of bends should be avoided. All ducting must be fire retardant.

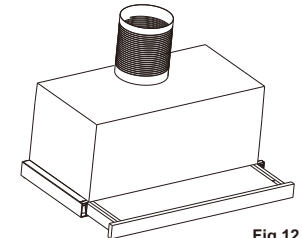

Fig.12

RANGE HOOD INSTALLATION

5. Electrical connection:

Electrical wiring must be done by a qualified person(s) in accordance with all applicable codes and standards. Turn off electrical power at service entrance before wiring .

If the supply cord is damaged, it must be replaced by the manufacturer, its service agent or similarly qualified persons in order to avoid a hazard.

Do not use the plug and an extension cord other than the ones initially supplied with the hood.

OPERATION

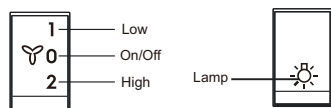

Fig.13

MAINTENANCE AND CARE

The hood must always be disconnected from the electricity supply before beginning any maintenance work.

Cleaning the hood

- Clean the outside of the hood using a damp cloth and a solution of water and mild washing up liquid.
- Never use corrosive, abrasive or flammable cleaning products or products containing bleach .
- Never insert pointed objects in the motor's protective grid.
- Only ever clean filter using a damp cloth and mild washing up liquid.
- It is extremely important to clean the unit and change the charcoal filters at the recommended intervals. Failure to do so will cause grease deposits to build up that could constitute a fire hazard.

Metal grease filter

- The purpose of the grease filters is to absorb grease particles which form during cooking and it must always be used, either in the external extraction or internal recirculation function .

Attention:

The metal grease filters must be removed and washed every three weeks.

Removing the metal grease filters

1. Pull down the latch of filter.(Fig.14)
2. Take down the filter from body.

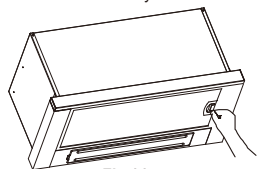

Fig.14

To replace lamp(Fig.15)

1. Take off the lamp cover.
2. Loosen the lamp anticlockwise.
3. Replace with 2W E14 LED lamp.

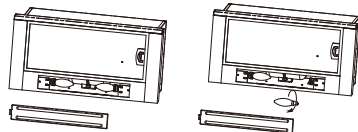

Fig.15

TROUBLE SHOOTING

Problem	Remedy
The cooker hood will not start	Check that the hood is connected to an electrical supply Check that a fan speed has been selected
The Rangehood is not working	Check that the fan speed is set high enough for the task The grease filters are clean The kitchen is adequately vented to allow the entry of fresh air If set up for recirculation, check that the charcoal filter is still effective If set up for extraction, check that the duct and outlets are not blocked Do not operate cooktop without pots/pans Do not flambe under cooktop
The rangehood has switched off during operation	The safety cut-out device has been tripped-turn off the hob and wait for the device to reset. If the hood has been installed below the heights indicated in the installation instructions the motor will cut out frequently which will damage the hood

If you have completed all the above checks and are still experiencing difficulty, please contact your local Electrolux Service Centre.

Note: This product is fitted with a safety cutout device.

- If the rangehood is installed too close to the cooker top, flambe cooking, operating the cooktop without cooking utensils and blocked filters may activate the safety cutout device. If the hood stops during operation, correct the faults and allow time for the safety cutout device to reset. Then the rangehood will function correctly.
- Do not operate cooktop without pots/pans
- Do not flambe under cooktop

CONSUMER CARE CENTER

<p>Thailand Consumer Care Tel : (+66 2) 725 9000 Electrolux Thailand Co., Ltd. Electrolux Building 14th Floor 1910 New Phetchaburi Road, Bangkapi, Huai Khwang, Bangkok 10310 Office Tel : (+66 2) 7259100 Office Fax : (+66 2) 7259299 Email : customercarethai@electrolux.com</p>	<p>Singapore Consumer Care Center Tel: (+65) 6727 3699 Electrolux S.E.A. Pte Ltd. 351 Braddell Road #01-04, 351 On Braddell Singapore 579713 Email : customer-care.sin@electrolux.com</p>
<p>Indonesia Hotline service: 08041119999 PT. Electrolux Indonesia Electrolux Building Jl.Abdul Muis No.34, Petojo Selatan, Gambir Jakarta Pusat 10160 Email:customercare@electrolux.co.id SMS & WA : 0812.8088.8863</p>	<p>Philippines Consumer Care Center Toll Free: 1-800-10-845-CARE(2273) Consumer Care Hotline:(+63 2)845-CARE(2273) Electrolux Philippines,Inc. Unit B 12F Cyber Sigma Bldg, Lawton Avenue, McKinley West,Taguig, Philippines 1634 Trunkline:+63 2 737-4757 Website:www.electrolux.com.ph Email:wecare@electrolux.com</p>
<p>Vietnam Consumer Care Center Toll Free 1800-58-88-99 Tel: (+84 28) 39105465 Electrolux Vietnam Ltd. Unit 1&2, 10F Sofic Tower, #10 Mai Chi Tho Street, Thu Thiem Ward, Thu Duc City, Ho Chi Minh City, Vietnam</p>	<p>Malaysia Consumer Care Center Tel: 1300-88-11-22 Electrolux Home Appliances Sdn. Bhd. Corporate Office Address: Unit T2-7, 7th Floor, Tower 2, PJ33, No. 3, Jalan Semangat, Seksyen 13, 46200 Petaling Jaya, Selangor. Office Tel : (+60 3) 7843 5999 Office Fax : (+60 3) 7955 5511 Consumer Care Center Address: Lot C6, No. 28, Jalan 15/22, Taman Perindustrian Tiong Nam, 40200 Shah Alam, Selangor Consumer Care Center Fax : (+60 3) 5524 2521 Email : malaysia.customercare@electrolux.com</p>
<p>HONG KONG SERVICE HOTLINE: (+852) 3193 9888 DCH ELECTRICAL APPLIANCES SERVICE CENTRE 4/F, DCH BUILDING, 20 KAI CHEUNG ROAD, KOWLOON BAY, HONG KONG EMAIL: customercare@dch.com.hk WEBSITE: www.electrolux.com.hk</p>	

www.electrolux.com

The Thoughtful Design Innovator.

Do you remember the last time you opened a gift that made you say, "Oh! How did you know? That's exactly what I wanted!" That's the kind of feeling that we at Electrolux seek to evoke in everyone who chooses or uses one of our products. We devote time, knowledge, and a great deal of thought to anticipating and creating the kind of appliances that our customers really need and want.

This kind of thoughtful care means innovating with insight. Not design for design's sake, but design for the user's sake. For us, thoughtful design means making appliances easier to use and tasks more enjoyable to perform, freeing our customers to experience the ultimate 21st century luxury: ease of mind. Our aim is to make this ease of mind more available to more people in more parts of their everyday lives, all over the world.

The "Thinking of you" promise from Electrolux goes beyond meeting the needs of today's consumers. It also means we're committed to making appliances safe for the environment—now and for future generations.

Electrolux. Thinking of you.

Share more of our thinking at
www.electrolux.com